

BECKHOFF New Automation Technology

PC-based Control for Robotics in Handling, Production and Assembly





IPC



I/O



Motion



Automation

PC-based control: The open, high-performance control platform ...

PC-based control from Beckhoff is a comprehensive automation platform for highly efficient and customisable handling, production and assembly applications. With its openness and flexibility, PC-based control helps users achieve considerable competitive advantages in technology and business. A total of 34 Beckhoff subsidiaries and branches as well as distributors provide technological support in the local language of over 75 countries. The continuous economic growth of Beckhoff and large production capacities ensure delivery reliability and long-term availability. Robust, industry-proven components and compliance with high-performance, future-proof IT and PC standards offer impressive investment security and ample technological reserves.

* as of April 2016



... for complete production lines.

PC-based control is highly modular and precisely scalable with regard to each application's individual performance requirements. It is well-suited for controlling and monitoring the whole process chain of individual machines and complete production lines: Feeding, joining (welding, gluing, etc.), assembly, checking, handling and palletising can all be universally automated with Beckhoff Industrial PCs as the hardware platform, TwinCAT as the automation software and EtherCAT as the communication system. Since all control functions are mapped in software, production cells or production lines can be flexibly adapted to changing requirements, and new functionalities can be integrated without significant engineering effort. The continuously increasing performance of advanced computing devices and the open control architecture of PC Control meet all conceivable requirements in terms of functionality and connectivity.

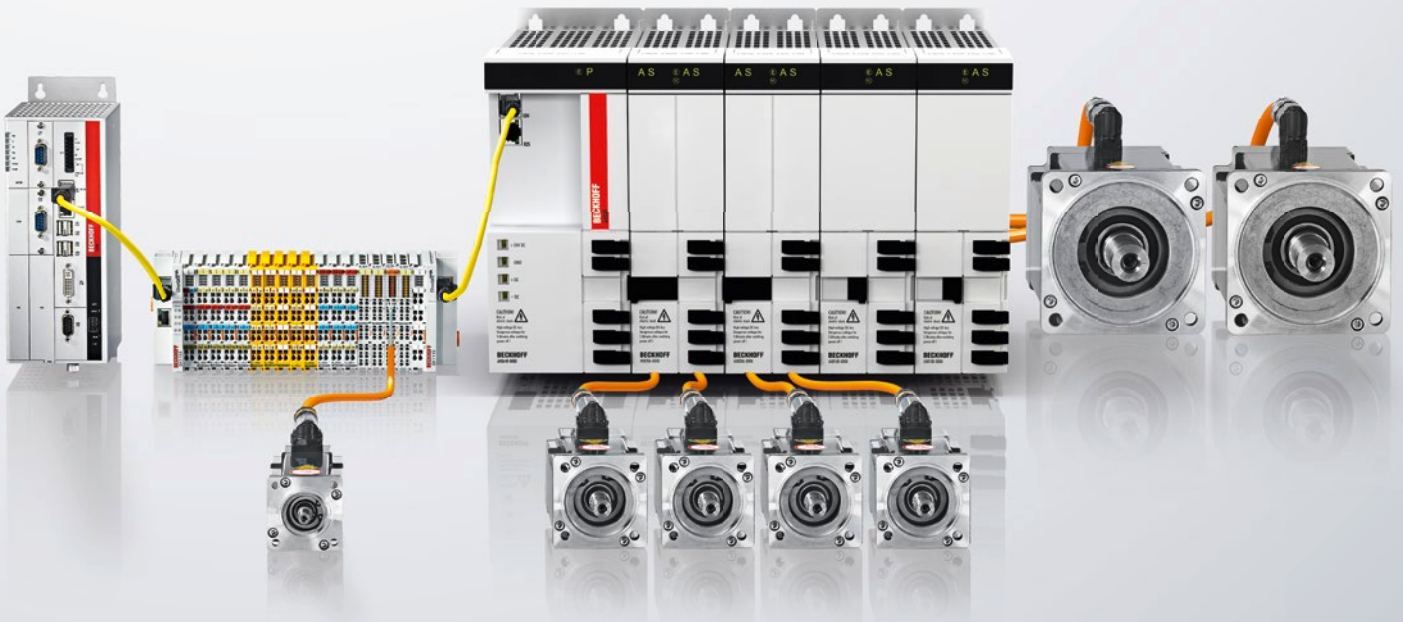
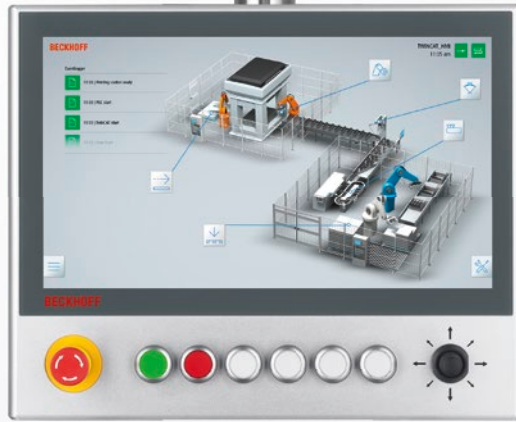

PC-based control integrates robotics and condition monitoring into the standard control platform ...

PC Control is based on an integrated hardware and software platform that consists of an Industrial PC, EtherCAT as the high-performance bus system, distributed I/Os, drives and TwinCAT, the integrated software for engineering, processing, simulation and diagnostics of all control functions. Based on the high performance of multi- and many-core processors, PLC, HMI, motion control, safety technology, robotics and measurement technology can be implemented in software and run side by side on a centralized PC platform. Open hardware and software interfaces, in conjunction with support for all common fieldbus systems and software protocols as well as Industrie 4.0 products, enable integrated communication from the field level to the cloud.

Feeding



Assembly

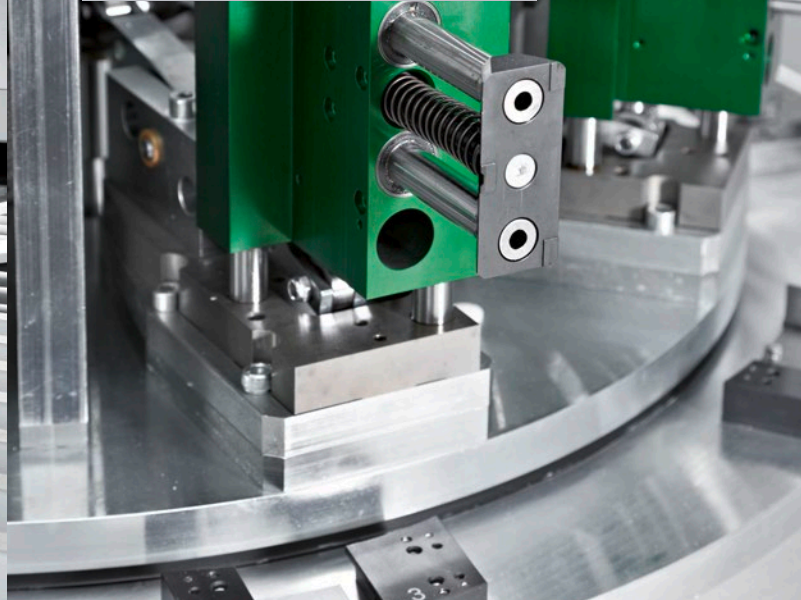

Checking

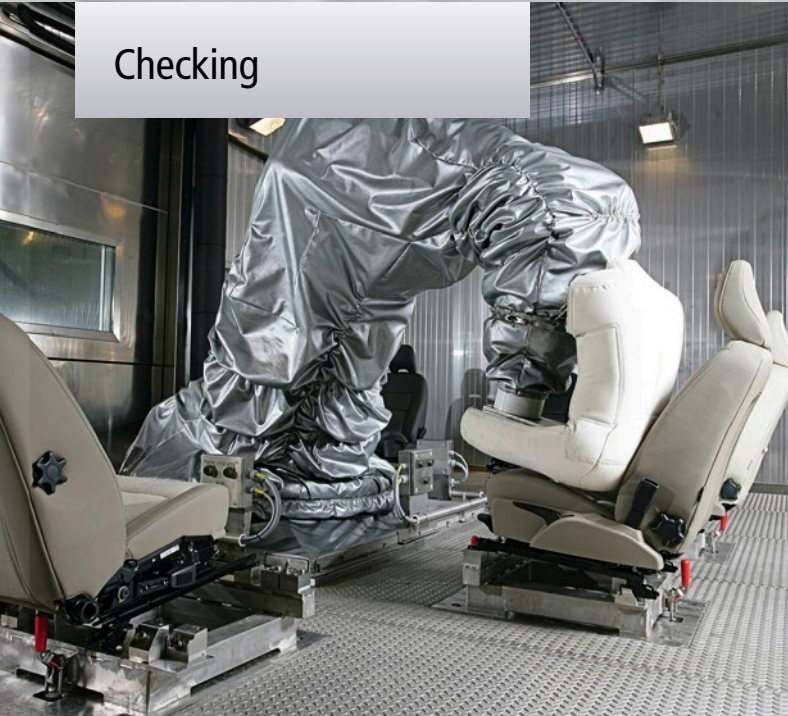

Handling

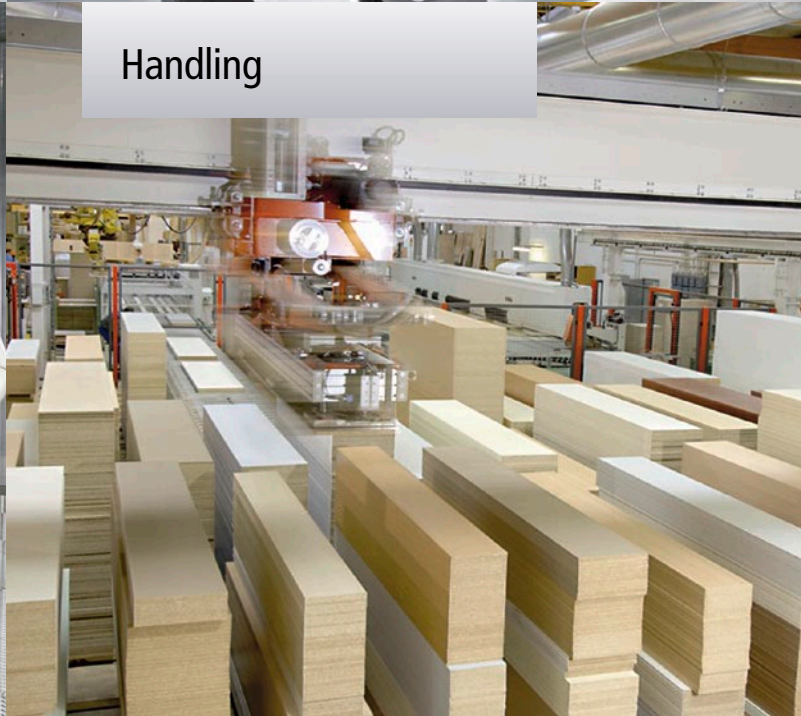

... optimising production processes and providing a technological foundation for Industrie 4.0.

PC- and EtherCAT-based control technology meets the highest requirements with regard to communication, interfaces, handling of large data quantities and performance reserves. TwinCAT handles all control tasks, from simple PLC functionalities to the calculation of complex mathematical algorithms for measurement analytics or robot kinematics. High dynamics and repeatability are achieved through the seamless integration of robotics into the machine controller. At the same time, the hardware costs and requirements for engineering, cabling and warehousing are substantially reduced. Furthermore, condition monitoring and energy data management according to the ISO 50001 standard can be easily integrated via measurement terminals: Data can be acquired via system-integrated EtherCAT Terminals and processed in the central control system. For storage, management and analysis of large data volumes, cloud-based services can also be used with TwinCAT.

PC-based control for all application areas, such as:

Feeding

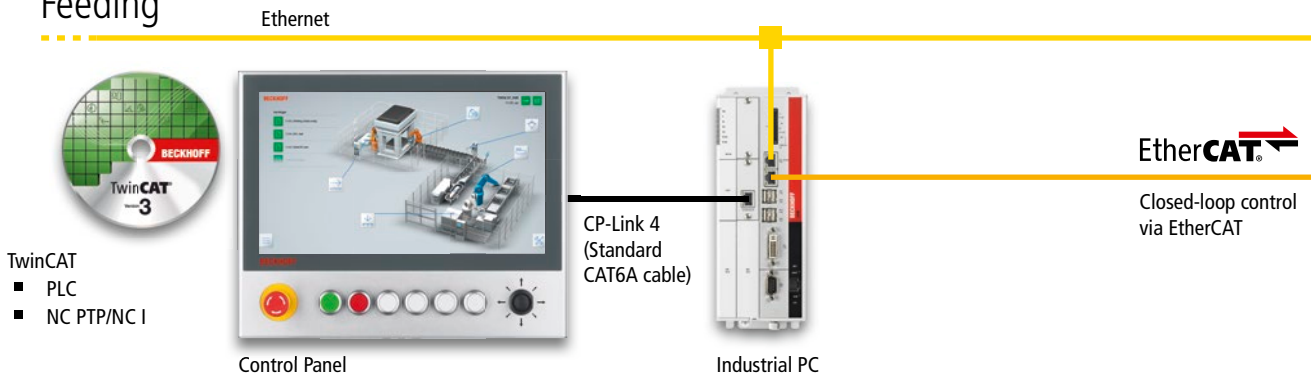

Assembly

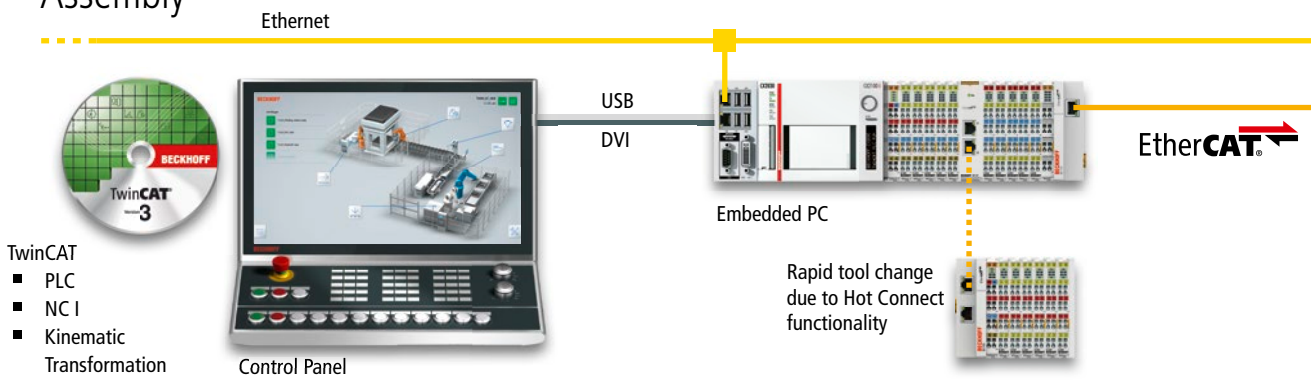

Checking

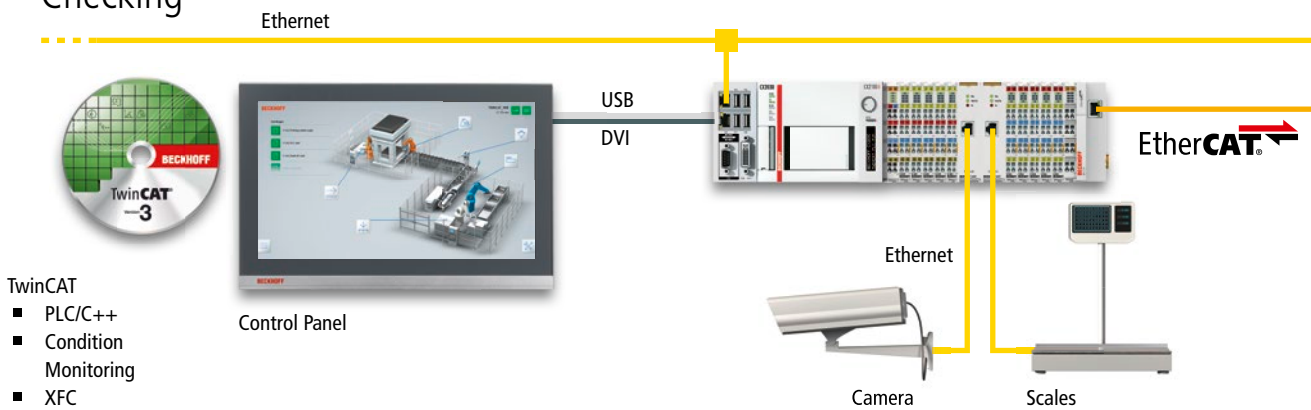

Handling

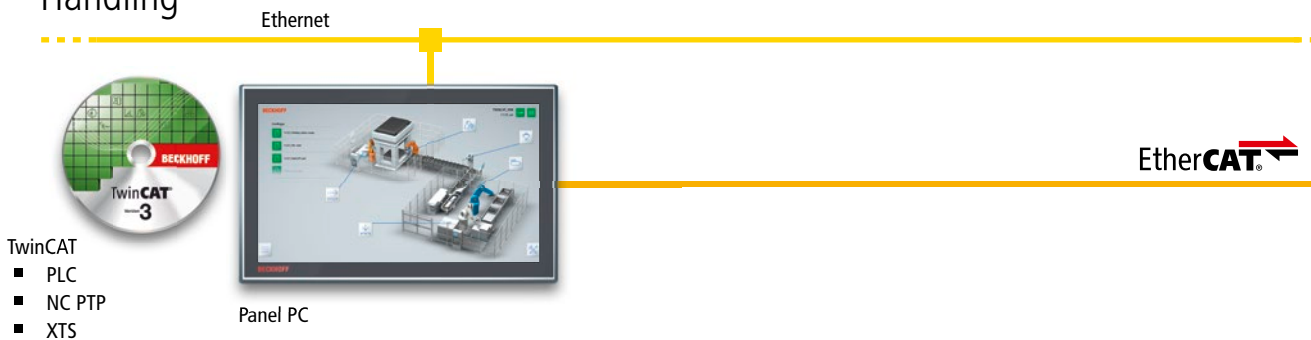



EtherCAT Terminals

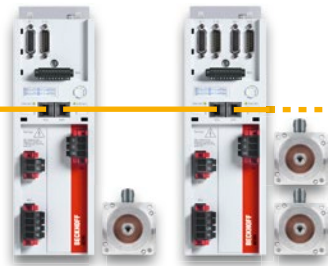

EtherCAT Servo Drives
x-axis y-/z-axis

The precise guidance of multiple coupled axes is just one of the strengths of TwinCAT automation software from Beckhoff. An especially space-saving solution for controlling a gantry portal with three axes, for example, can be realised with two-channel servo drives. TwinSAFE, the programmable safety solution from Beckhoff, includes safe inputs and outputs as well as drive technology with integrated safety functionality.

► www.beckhoff.com/Motion

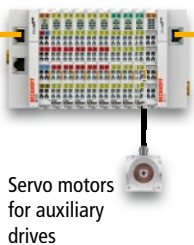

Servo motors for auxiliary drives



EtherCAT Box



6-axis articulated robot



Auxiliary axes

Gantry and articulated robots are frequently used to carry out assembly steps such as joining, gluing, screwing, welding, etc. PC- and EtherCAT-based control offers ample performance to control many axes simultaneously. Fast tool changes can be achieved with the EtherCAT Hot Connect function. Specific TwinCAT software modules support direct communication via robot interfaces such as uniVAL PLC (Stäubli) or KRC4 (KUKA).

► www.beckhoff.com/TF5120
► www.beckhoff.com/TF5130

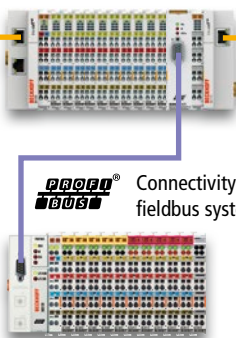

PROFIBUS[®] DP
Connectivity to other fieldbus systems

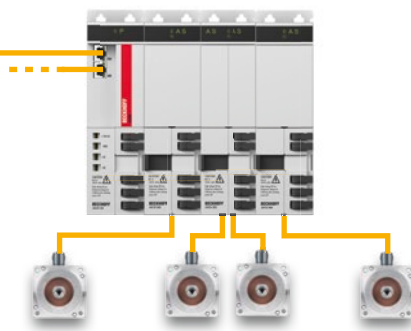

Feeding Checking cycle Further transport

The integration of testing systems into the control platform has become a prerequisite for ensuring consistent production quality. Devices with essentially any fieldbus interface can be integrated with PC-based control, due to the large interface variety offered by TwinCAT. Condition monitoring terminals are available to simply and cost-effectively integrate condition monitoring functions for machines and systems into the PC platform, all without the need for special stand-alone hardware.

► www.beckhoff.com/Condition-Monitoring

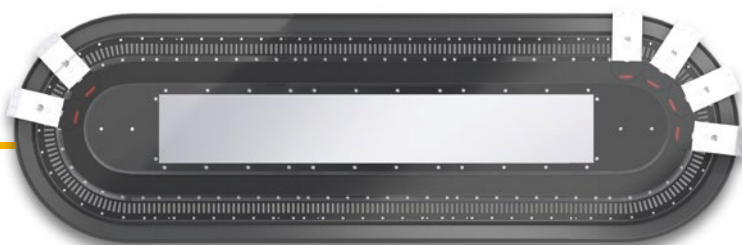

XTS – eXtended Transport System

The linear transport system XTS enables highly individual product transport, i.e. different travel commands can be executed simultaneously. The movers – cable-free carrier modules – move at up to 4 m/s and transport the products/workpieces very accurately to the next processing station. Due to the small overall installed size of the XTS, machine manufacturers are able to design and build space-saving machines.

► www.beckhoff.com/XTS



TwinCAT, the open automation software ...

TwinCAT is the integrated platform for engineering, control, measurement technology, diagnostics and analytics functions. Support for all common fieldbus systems and software protocols guarantees integrated communication from the IT level to the field level. With IEC 61131-3, C/C++ and an open interface to MATLAB®/Simulink®, a wide range of programming languages are available for any task. Numerous PLC libraries with function blocks according to the PLCopen Motion Control standard simplify programming. The multi- and many-core control capabilities of TwinCAT 3 lead to considerable increases in performance: for example, it becomes possible to implement extensive data analysis and robotics functionality without negatively impacting control performance. With a vision for the future and useful tools available today, TwinCAT IoT and TwinCAT Analytics are products that enable the true realisation of Industrie 4.0 solutions.

► www.beckhoff.com/TwinCAT

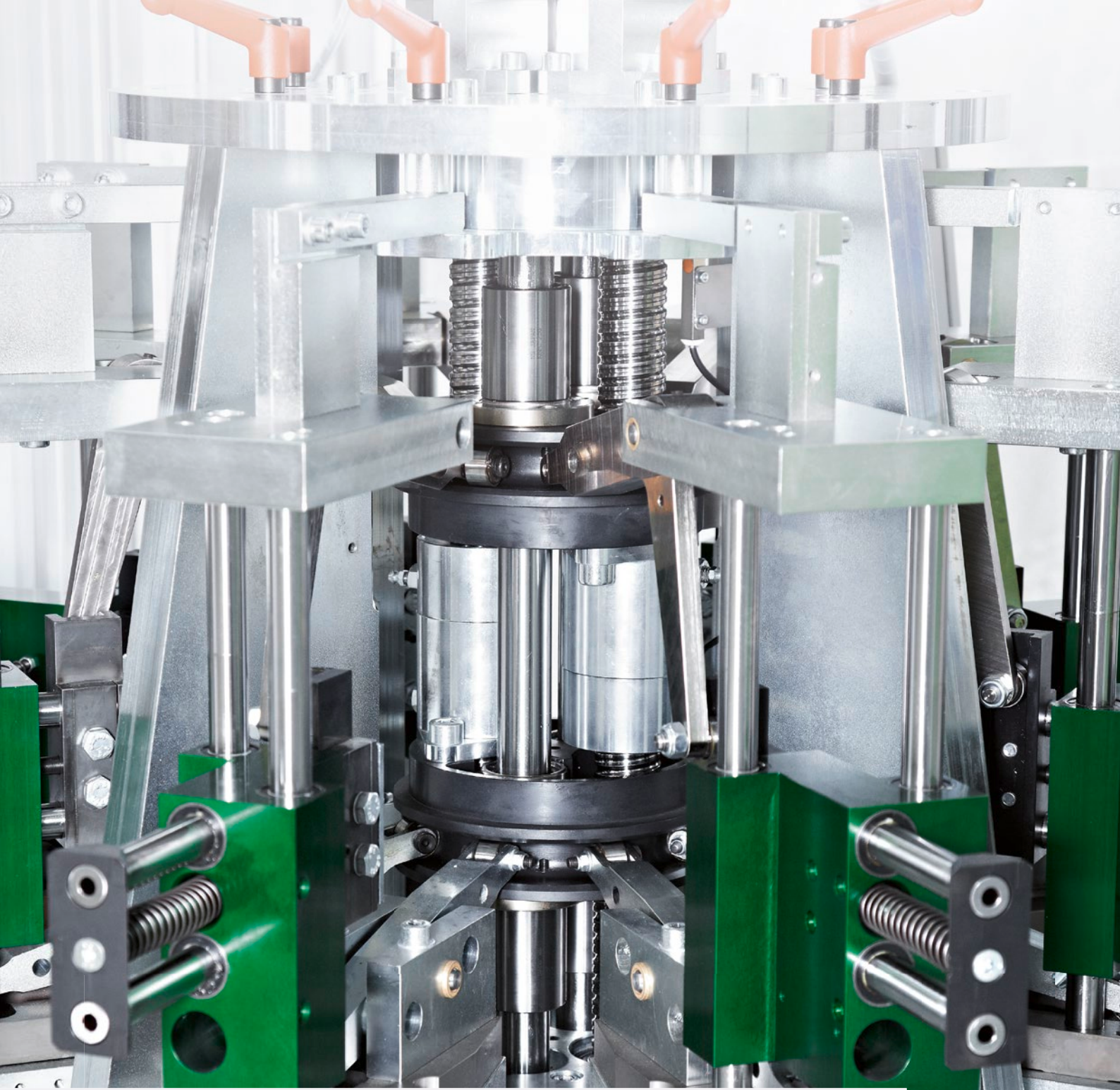

... integrates engineering and runtime on one platform.

As an integrated software suite, TwinCAT dramatically reduces engineering time and cost. Robotic and motion control functions can be synchronised on a single platform based on TwinCAT NC PTP (point-to-point axis positioning) or NC I (axis interpolation in three dimensions). All NC features such as "cam plates" or "flying saw" can be combined on a common hardware and software platform. TwinCAT enables the programming of virtually any robot kinematics type in standard PLC programming languages. This promotes efficient engineering processes and reduced engineering costs. In addition, the ability to integrate C and C++ code in TwinCAT 3 ensures that existing robot kinematics can be reused, while MATLAB®/Simulink® support enables the use of existing models when implementing controllers or simulations.



TwinCAT provides software support for all common robot kinematics ...

TwinCAT Kinematic Transformation integrates robot control into standard automation software, so that PLC, motion control and robotics functions can be executed on a single Industrial PC. 6-axis kinematics is also available in addition to Cartesian gantry, serial 2-D kinematics, 2-D parallel kinematics and 3-D Delta kinematics. The desired kinematics can be conveniently selected and parameterised in the TwinCAT System Manager. The kinematic channel is used to parameterise the robot type (e.g. delta or SCARA) as well as the bar lengths and offsets. Values for mass and mass inertia can be specified for dynamic pre-control. In addition, this TwinCAT software library includes tracking functionalities for synchronising a robot with a moving object, so it can pick up workpieces from conveyor belts or inclined turntables, for example.

► www.beckhoff.com/TF5110

The 'TwinCAT Kinematic Transformation' function requires TwinCAT NC I and is subdivided into four levels:

Level 4: includes level 3 as well as

- Serial 6-axis kinematics
- Hexapod
- 5-D kinematics



Serial 6-axis kinematics



Hexapod



5-D kinematics

Level 3: includes level 2 as well as more complex kinematics such as

- 3-D kinematics
- SCARA
- 3-D delta



3-D kinematics



SCARA



3-D delta kinematics

Level 2: includes level 1 as well as additional, simpler kinematic transformations:

- Shear kinematics
- Roller kinematics (H-Bot)
- 2-D parallel kinematics



Shear kinematics



Roller kinematics (H-Bot)



2-D parallel kinematics

Level 1: static transformation (translation and rotation) and various compensations

- Cartesian portal



Cartesian portal

... and maximises performance and system accuracy.

Using TwinCAT Kinematic Transformation, various parallel and serial kinematics such as those used for pick-and-place tasks can be realised simply and cost-effectively. The robot acts as an EtherCAT Slave so that communication with the Beckhoff controller is based on EtherCAT, a global standard in the robotics industry. The seamless integration of robot kinematics into the control system not only avoids the need for an additional robot CPU, it also ensures optimised interaction and synchronisation with the PLC and existing motion control functions: direct interfaces replace the complexities and inefficiencies of communicating between different controllers and systems. This results in much higher performance and improved system accuracy.



EL7201
Servo terminal

AX8000
Multi-axis servo system

AX5000
Compact Servo Drives

Scalable drive technology ...

The scalable drive solutions from Beckhoff cover a broad range of applications: including compact servo terminals, high-performance EtherCAT Servo Drives of the AX series, DC, stepper or servomotors, and the linear transport system XTS. The extensive range of linear and rotary servomotors is tailored perfectly to the Servo Drive series. EtherCAT provides the ideal link to PC-based control technology and supports connections to other communication systems. All conceivable kinematic systems and positioning tasks can be realised via TwinCAT motion functions.

► www.beckhoff.com/Motion



... for robots and cells.

Robot and handling applications require positioning, movement and highly dynamic travel of numerous axes, either individually or interdependently. The integrated, fast control technology of the AX5000 and AX8000 Servo Drive series enables fast and highly dynamic motion processes. The flexible design with 1- and 2-channel versions as well as the variable distribution of motor output allocation enables the implementation of cost-optimised solutions, in particular for assembly and handling systems. The One Cable Technology (OCT) of the AM8000 servomotor series, which combines previously separate power and sensor cables into one standard motor cable, saves mounting space and commissioning costs. With optionally integrated TwinSAFE technology, the servo drives meet stringent machine safety requirements while simplifying the configuration of production cells.

PC-based control as a technological foundation for Industrie 4.0

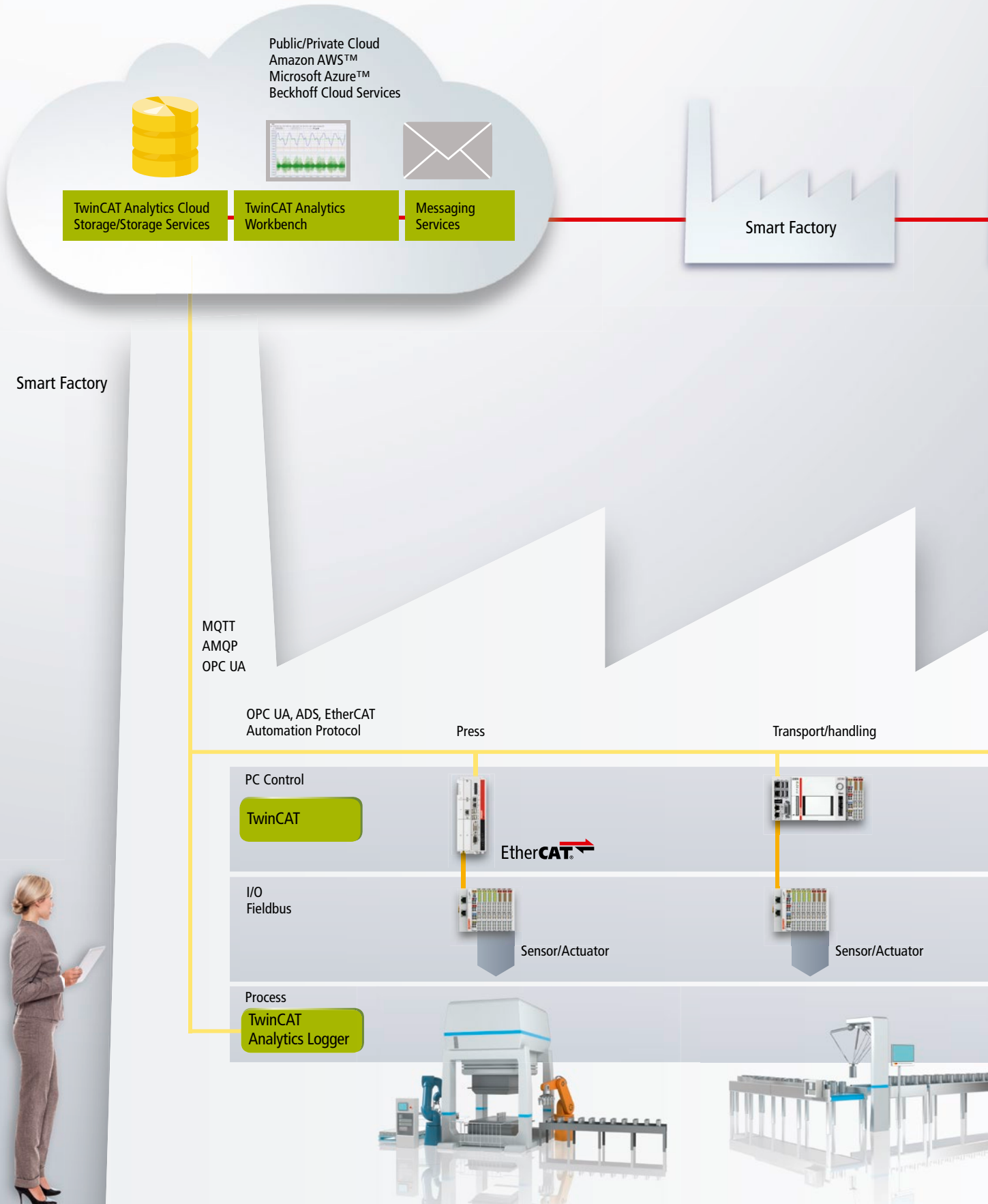

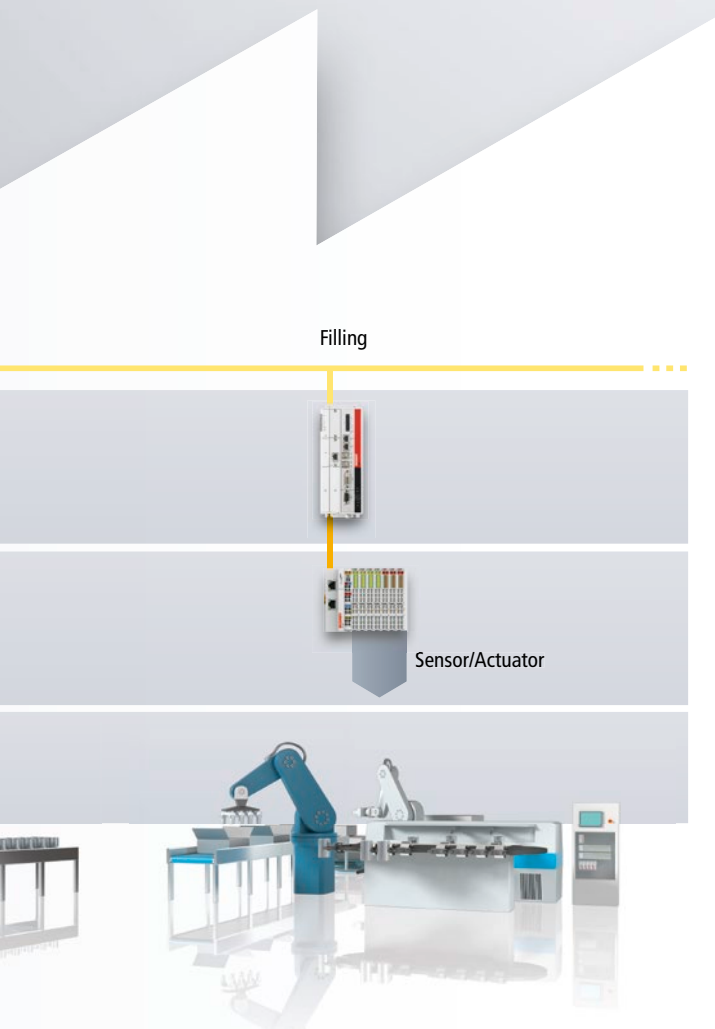

TwinCAT for Industrie 4.0 and the Internet of Things

Beckhoff provides the technological foundation for Industrie 4.0 concepts and Internet of Things (IoT) communication via standard PC-based control products. In addition to traditional control applications, TwinCAT engineering and control software enables the implementation of applications such as big data, pattern recognition and condition or power monitoring and thus sustainably increases production efficiency.

TwinCAT offers dedicated modules for simple cloud communication and for data analytics functions: TwinCAT IoT supports all common protocols for cloud communication and for 'push messages' to smart devices. TwinCAT IoT is quick and easy to configure and, together with an Industrial or Embedded PC as an IoT controller, establishes a seamless connection between the Internet of Things and the Internet of Services.

"TwinCAT Analytics" saves process data locally, on the server or in the cloud in synchronisation with the control cycle. All data are recorded to serve as the basis for comprehensive analyses. This enables the implementation of predictive maintenance solutions and minimises machine downtime.

PC-based control – one control platform for the entire production line

Press

Blank material feeding



- Condition Monitoring
- Energy data management
- Big Data
- Cloud connectivity

Filling

XTS PC Control

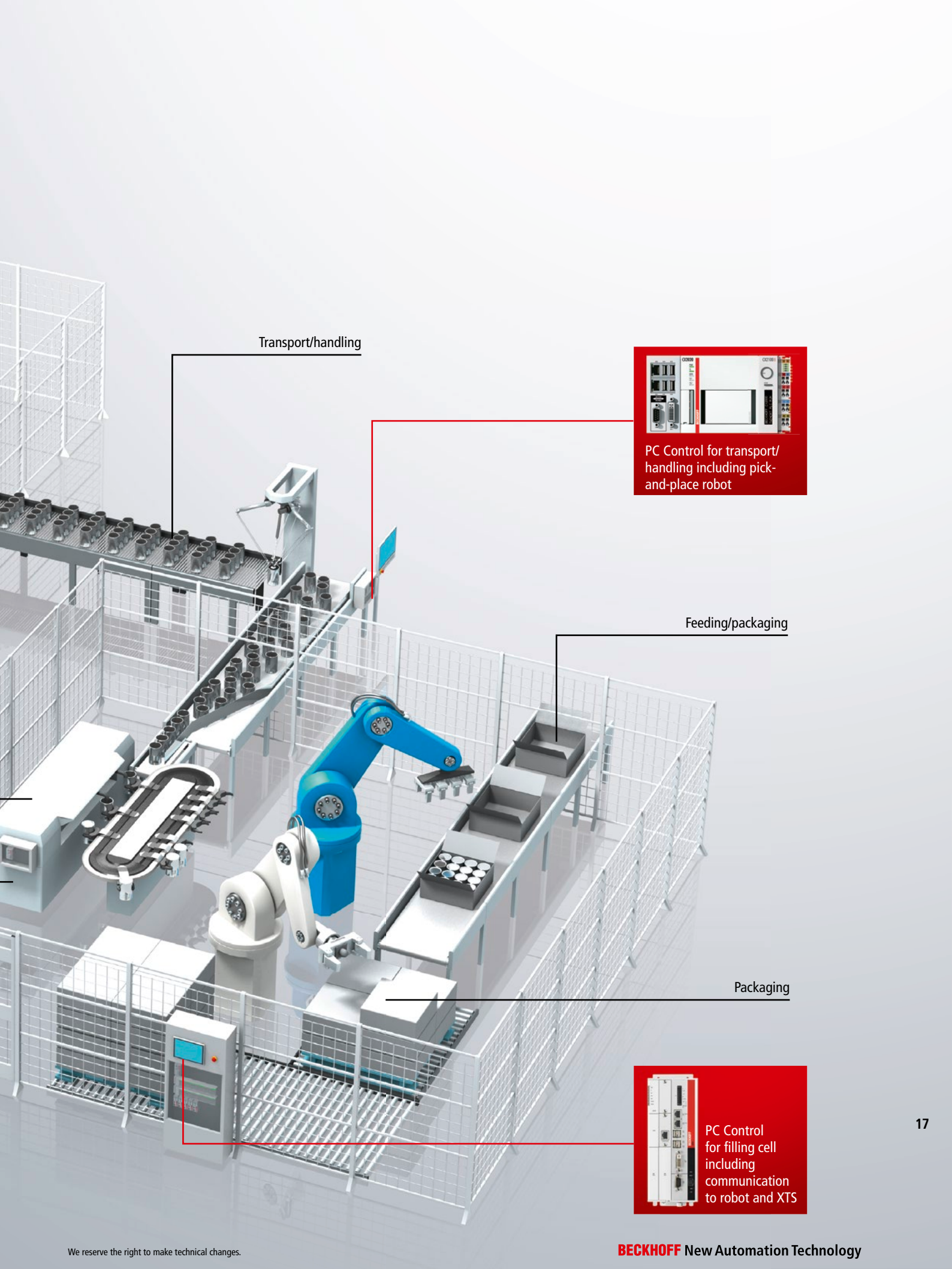

Transport/handling



PC Control for transport/
handling including pick-
and-place robot

Feeding/packaging

Packaging



PC Control
for filling cell
including
communication
to robot and XTS

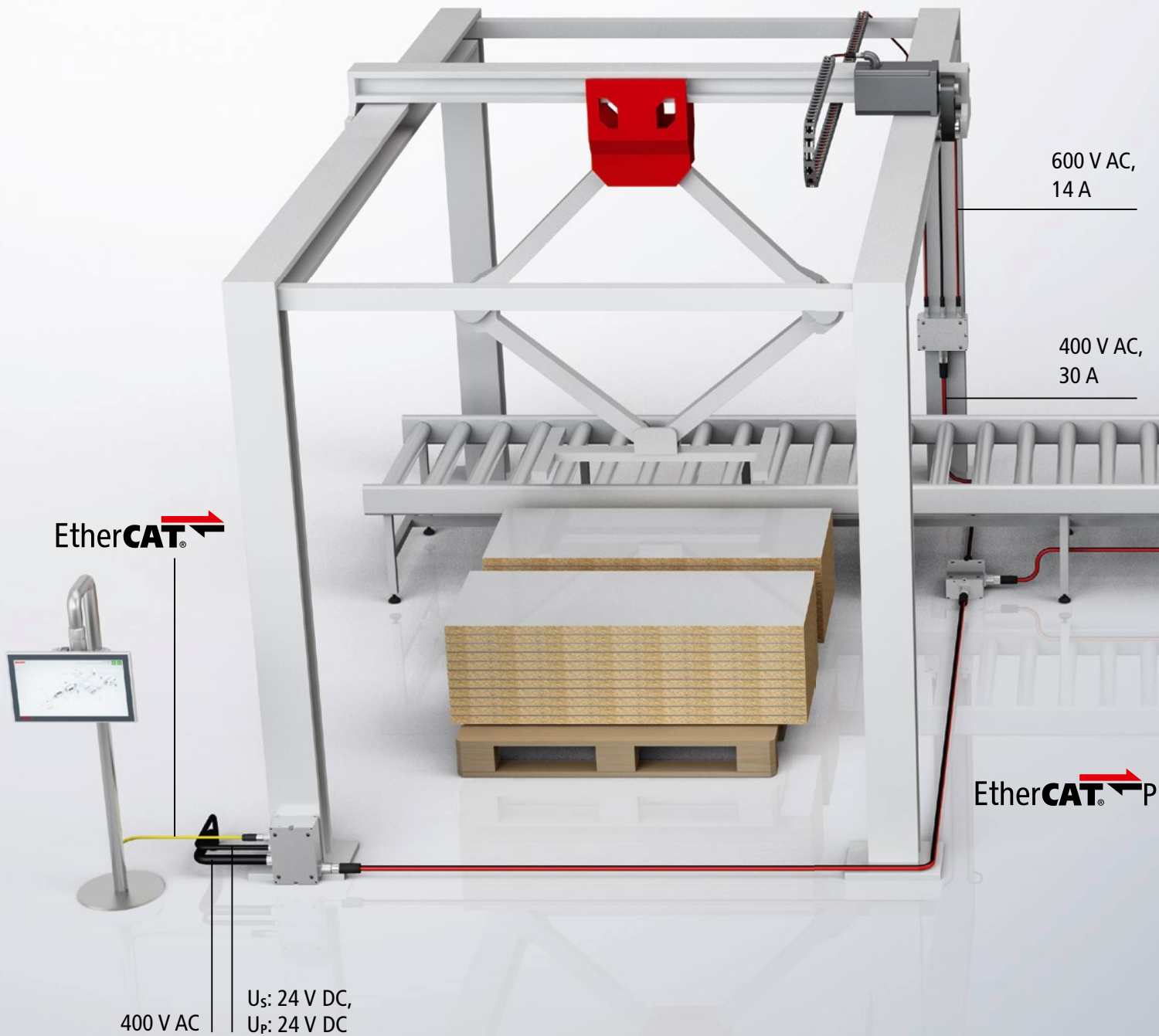

EtherCAT P – One Cable Automation for the field level ...

EtherCAT P combines EtherCAT communication with the power supply for connected consumers on a standard four-wire Ethernet cable. In addition, EtherCAT P enables the direct forwarding of power supply via the devices. All benefits of EtherCAT are retained, including free choice of topology, high speed, optimum bandwidth utilisation, dynamic on-the-fly processing of telegrams, high-precision synchronisation, extensive diagnostics and more. This makes EtherCAT P the ideal bus system and cabling technology for sensors, actuators and measurement technology. One Cable Automation significantly simplifies system wiring and reduces machine footprint, since components, terminal boxes and machine modules can be linked via a single, streamlined cable.

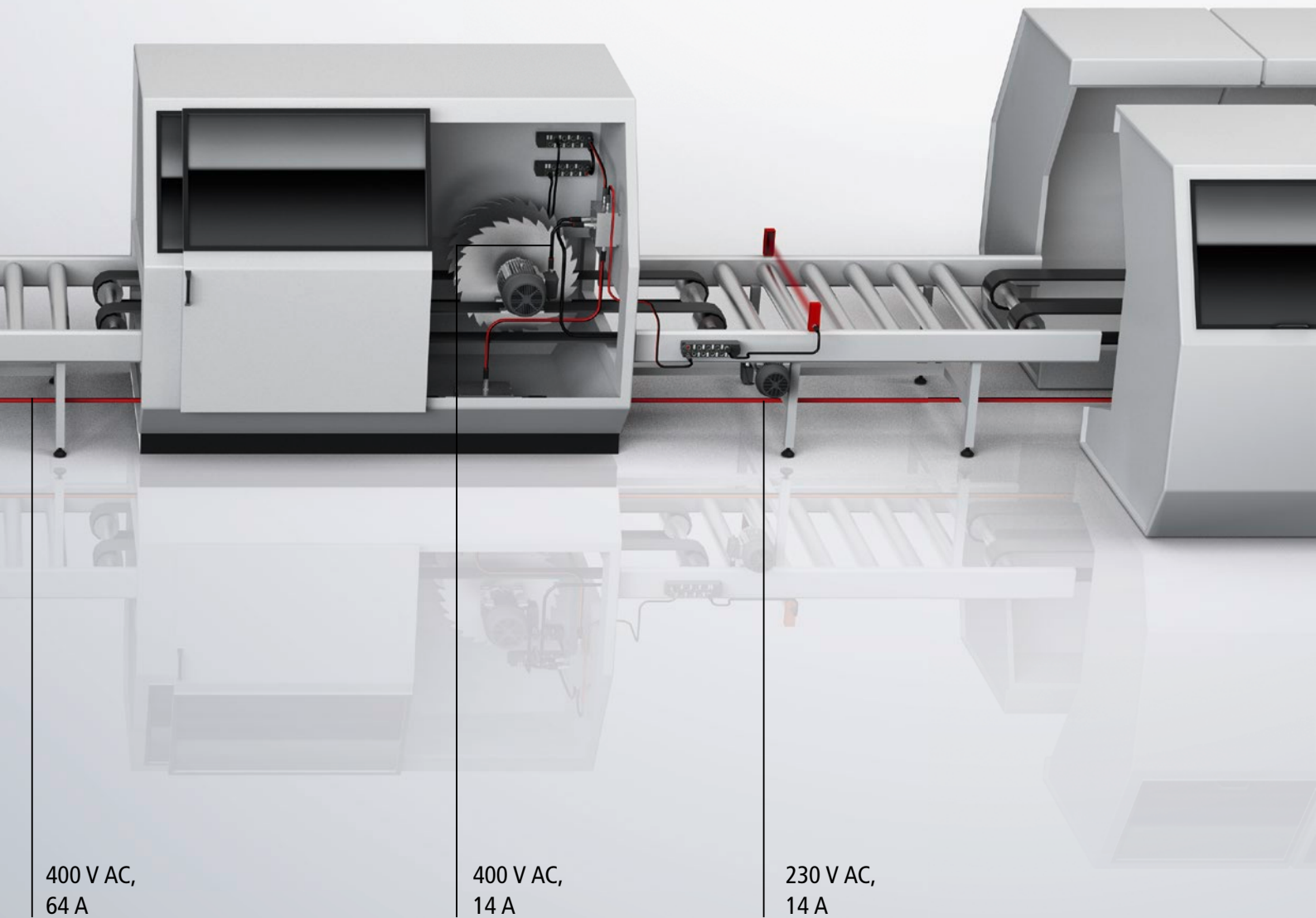

400 V AC,
64 A

400 V AC,
14 A

230 V AC,
14 A

... moves industry toward the era of cabinet-free machines.

In One Cable Automation, decentralised terminal boxes and individual machine modules or robot applications are supplied with control data and power via a single cable. As a result, the need for the large control cabinets of the past can be minimised or even eliminated and plant footprint become much smaller. With EtherCAT P, it is much easier to implement modular machines and system concepts with high flexibility along with considerably reduced installation and commissioning efforts. Material costs, equipment mounting and installation time are reduced, as is the potential for errors during the installation. Without a separate power supply, the size of sensors and actuators can be reduced, as can the space required for drag chains, control cabinets and, most importantly, the machine itself.

EtherCAT – Ultra-fast system communication for robot control

EAP (EtherCAT Automation Protocol)

Direct control of robot kinematics

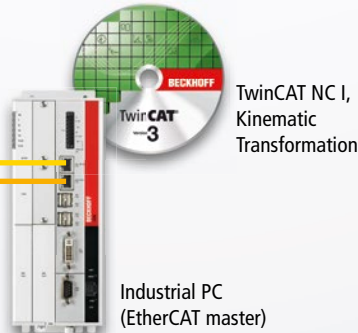

EtherCAT



EtherCAT Servo Drives AX5000

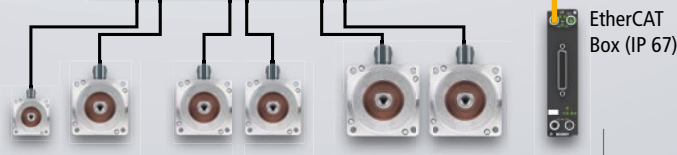

6-axis articulated robot

Direct control of pick-and-place robots and XTS

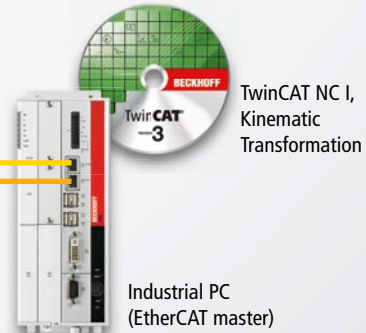

EtherCAT



EtherCAT Servo Drives AX8000

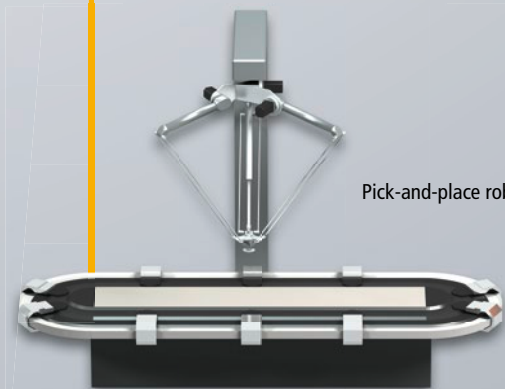
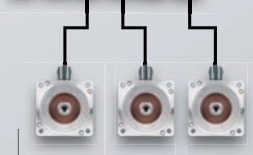

Pick-and-place robot

XTS (eXtended
Transport System)

Integration of an external robot controller in TwinCAT

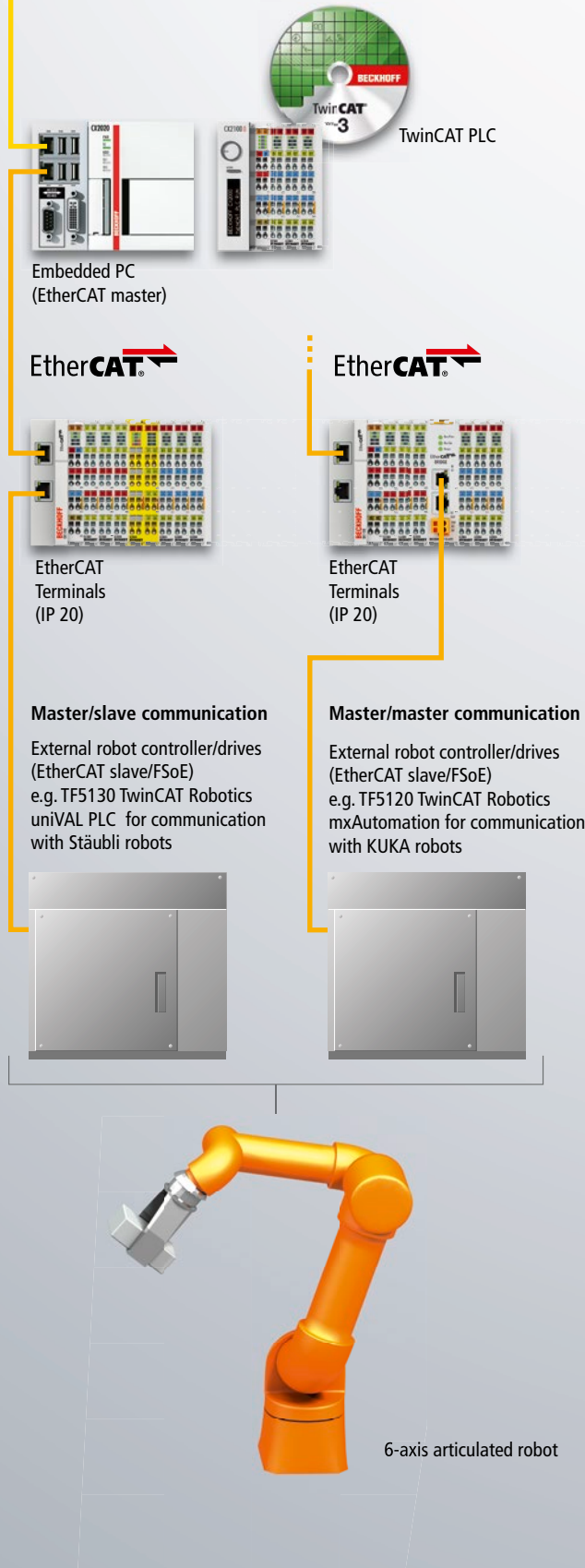

Direct control of robot kinematics

With TwinCAT Kinematics Transformation (TF511x) various robot kinematics can be controlled directly from TwinCAT software. For example, path planning and kinematic transformations are performed directly in TwinCAT. A wide range of kinematic systems already exist, and customer-specific components can be easily integrated.

Pick-and-place movements can also be programmed directly from the TwinCAT PLC; various libraries are available for this purpose. Path movements can be implemented with TwinCAT NC I according to DIN 66025; i.e. contours are described that are driven along with the robot.

Direct control of pick-and-place robots and XTS

One CPU for everything: TwinCAT controls XTS and at the same time also a delta robot. As a result the user only needs a single engineering environment for programming the whole system, and cycle times can be optimised by eliminating the need for complex communication between different controllers.

Integration of an external robot controller in TwinCAT

The technology functions TF5120 and TF5130 as an extension to the TwinCAT PLC (TC1200) standard provide the basis for controlling articulated arm or SCARA robots. The traversing commands for the robot are sent directly to the robot control via the PLC. Specifically defined interfaces for KUKA robots with mxAutomation (TF5120) and Stäubli with uniVAL PLC (TF5130) enable the control of robot movements directly from TwinCAT.

The advantage for the user is clear: motion profiles for the robot application can be programmed directly from within TwinCAT PLC function blocks. Complex, direct robot programming is no longer required; the robot is set up with the aid of TwinCAT PLC.

Control communication via the EtherCAT Automation Protocol (EAP)

Horizontal communication between robots and machines or the interfacing with a central master computer can be carried out very efficiently via EAP. A high-performance industrial Ethernet technology, EAP enables real-time communication at millisecond intervals. The protocol is based on a conventional Ethernet infrastructure and can be transferred via any Ethernet medium, including wireless.

Beckhoff – New Automation Technology

Beckhoff implements open automation systems on the principle of PC-based control technology. The product range covers the main areas of Industrial PCs, I/O and fieldbus components, drive technology and automation software. Products are available for all applications that can be used as individual components or as complete, coordinated control systems. „New Automation Technology“ from Beckhoff stands for universal and industry-independent control and automation solutions that are used in a large variety of applications worldwide, ranging from CNC-controlled machine tools and wind turbines to intelligent building control.

► www.beckhoff.com

Beckhoff at a glance

- Headquarters: Verl, Germany
- Sales 2015: € 620 million (+22 %)
- Staff worldwide: 3,000
- Branch offices, Germany: 14
- Subsidiary companies/representatives, worldwide: 34
- Sales and support in more than 75 countries worldwide (as of 4/2016)

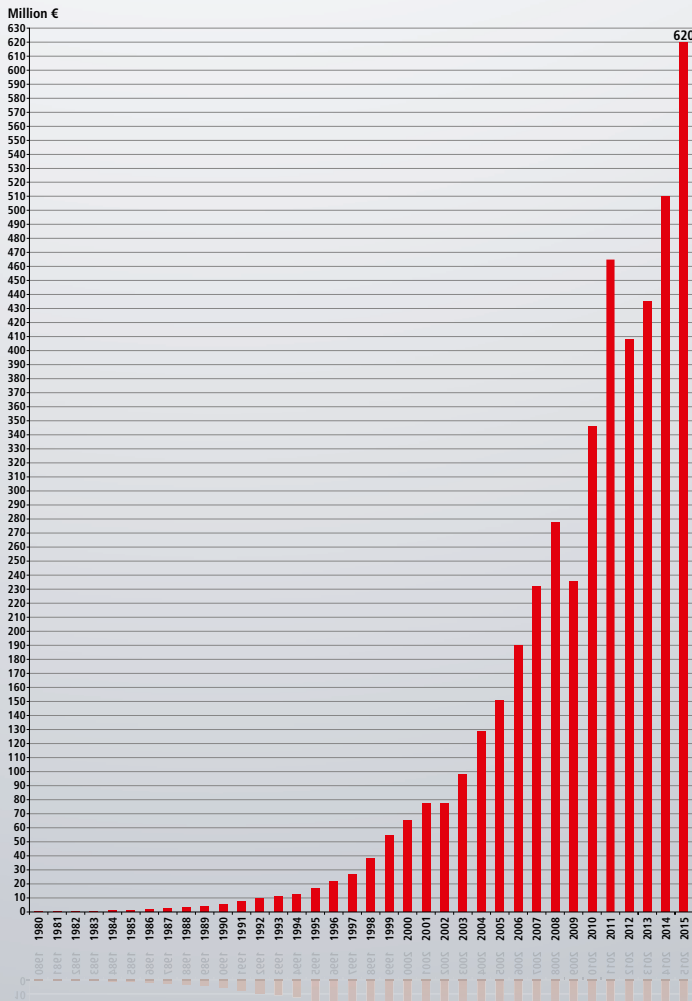

Turnover development



Worldwide presence on all continents

Through a strong presence in more than 75 countries, globally active Beckhoff customers benefit from fast service worldwide and technical support provided in the local language. Beckhoff regards geographic proximity to the customer as a prerequisite for a profound understanding of the unique technical challenges facing each customer.

Further information

Please refer to our web page "PC-based Control for Robotics in Handling, Production and Assembly" for additional information and industry-specific solutions.

▶ www.beckhoff.com/robotics

All Beckhoff catalogs and flyers are available for download from our website.

▶ www.beckhoff.com/media

Picture credits: IMA Automation Amberg GmbH | IMA Meinert GmbH | KUKA Roboter GmbH | Sodectia GTAC | STÄUBLI TEC-SYSTEMS GmbH Robotics | Venjakob Maschinenbau GmbH & Co. KG

Beckhoff®, TwinCAT®, EtherCAT®, EtherCAT P®, Safety over EtherCAT®, TwinSAFE®, XFC® and XTS® are registered trademarks of and licensed by Beckhoff Automation GmbH. Other designations used in this publication may be trademarks whose use by third parties for their own purposes could violate the rights of the owners. © Beckhoff Automation GmbH & Co. KG 05/2016

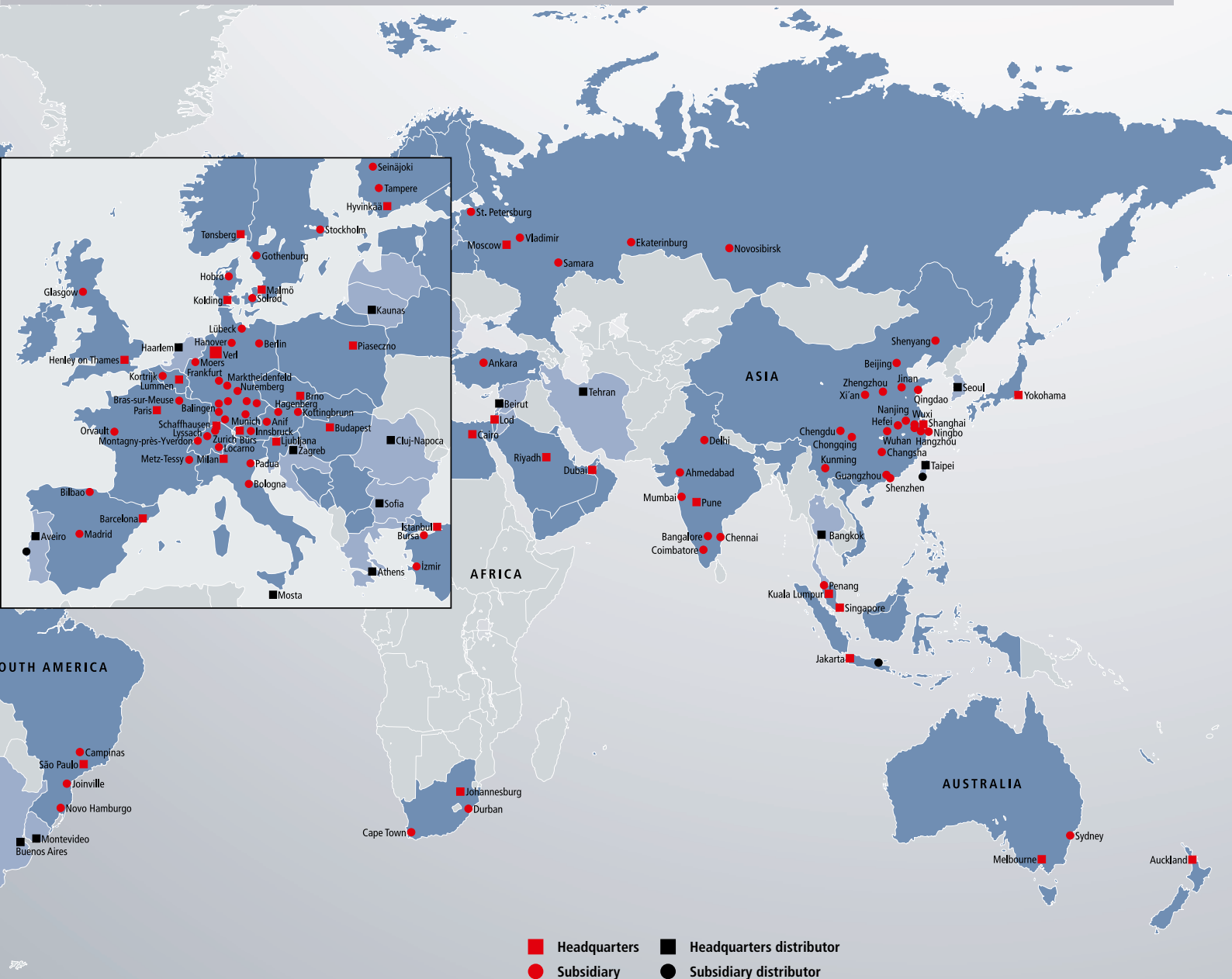

- Headquarters
- Subsidiary
- Headquarters distributor
- Subsidiary distributor

www.beckhoff.com/contact